

Machinery - Macchina	Weight-Peso Kg	Client reference- Rif.Cliente ALBERTONE SERRAMENTI S.R.L.	Part- Parte
REKORD HIGH TECHNOLOGY TOOLING REVOLTO (NO ITALY) - Via F. ZANUZI 16100/16105 REPLICATED DRAWING TRANSMISSION TO VENDERS IS FORBIDDEN RIPRODURRE, E TRASMETTERE A TERZI VEICOLI		Description ALZANTE SCORREVOLE 68	Drawing n°- Disegno n. 00C/1
Signature Firma	Scale Scala	Date Data	Code n°- Codice n. 07905 SERIE_TF 0029613
Revision Rev.	Date Data	Signature Firma	

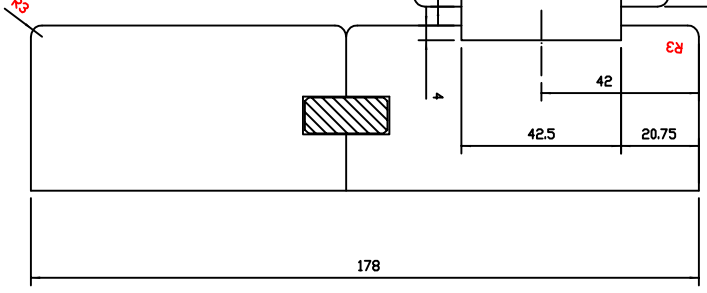
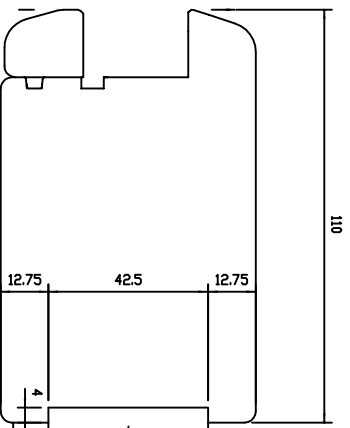
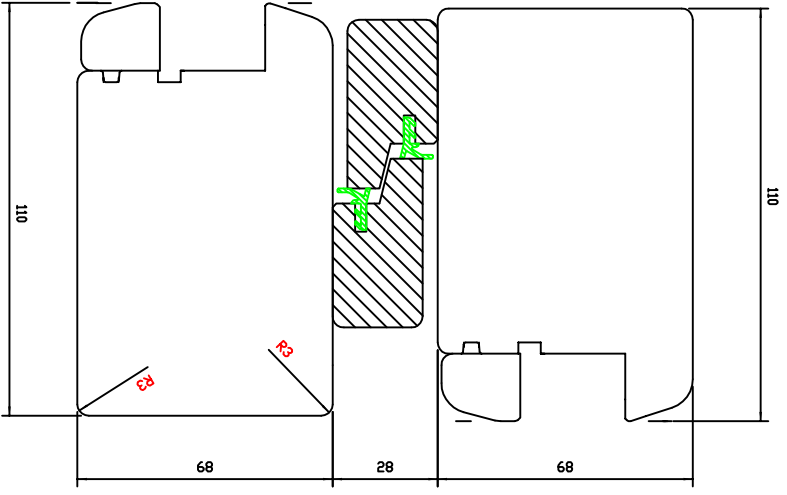
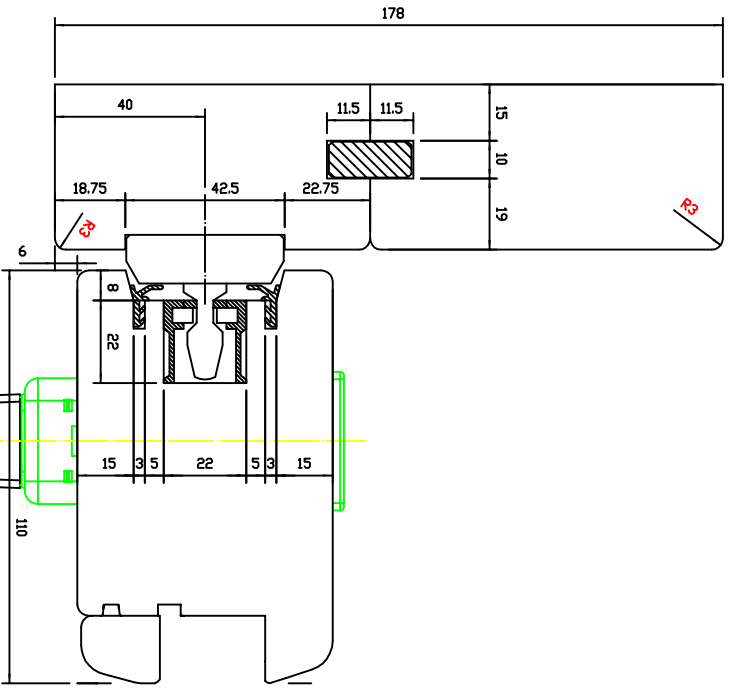
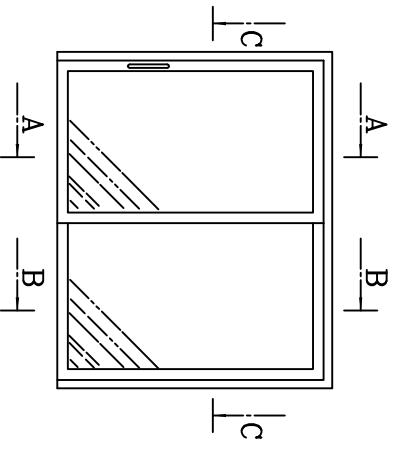
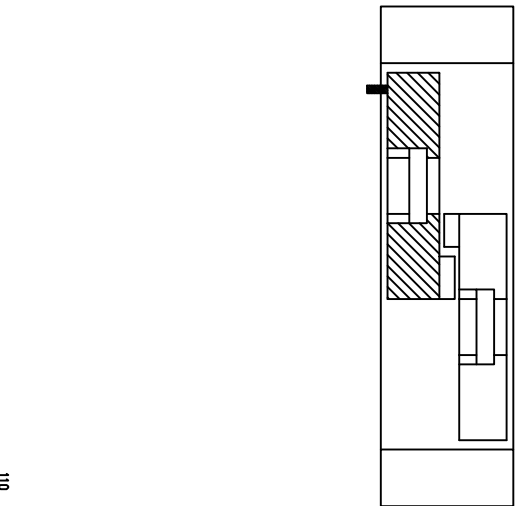
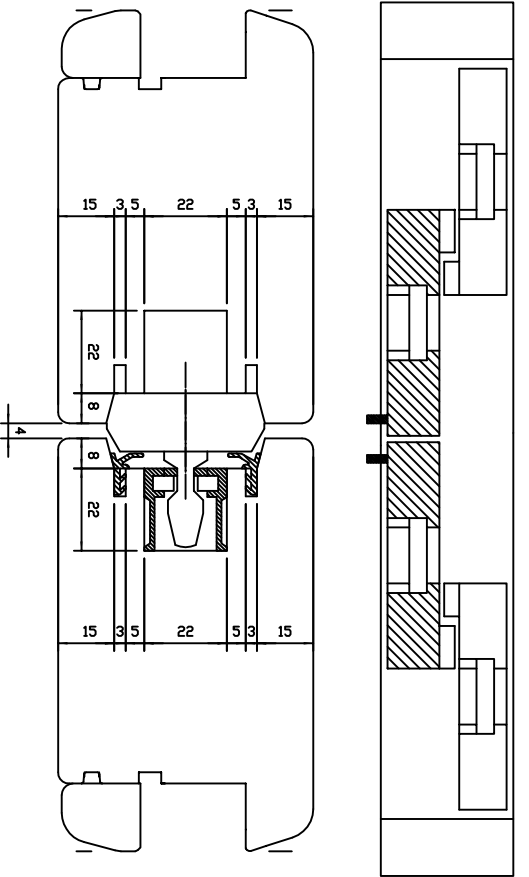

SEZ-CC

<p>REKORD HIGH TECHNOLOGY TOOLING SOLUZIONI PER IL TRATTAMENTO DI MATERIALI DURETTI CON L'USO DI STRUMENTI A TAGLIO RIVESTITI IN CARBONIO E TRATTATI</p>	<p>Machining - Macchine Vaghet-Fraso K9</p>	<p>Client reference - Ref. Cliente ALBERTONE SERAMENTI S.R.L.</p>	<p>Part - Parte Borsa - Borsa</p>
<p>Signature Firma</p>	<p>Description Descrizione</p>	<p>Signature Firma</p>	<p>Drawing n° - Design n° 00C/2</p>
<p>Scale Scala</p>	<p>Signature Firma</p>	<p>Signature Firma</p>	<p>Code n° - Codice n° 07905 SERIE_LF 0029613</p>
<p>Date Data</p>	<p>Date Data</p>	<p>Date Data</p>	<p>Date Data</p>