

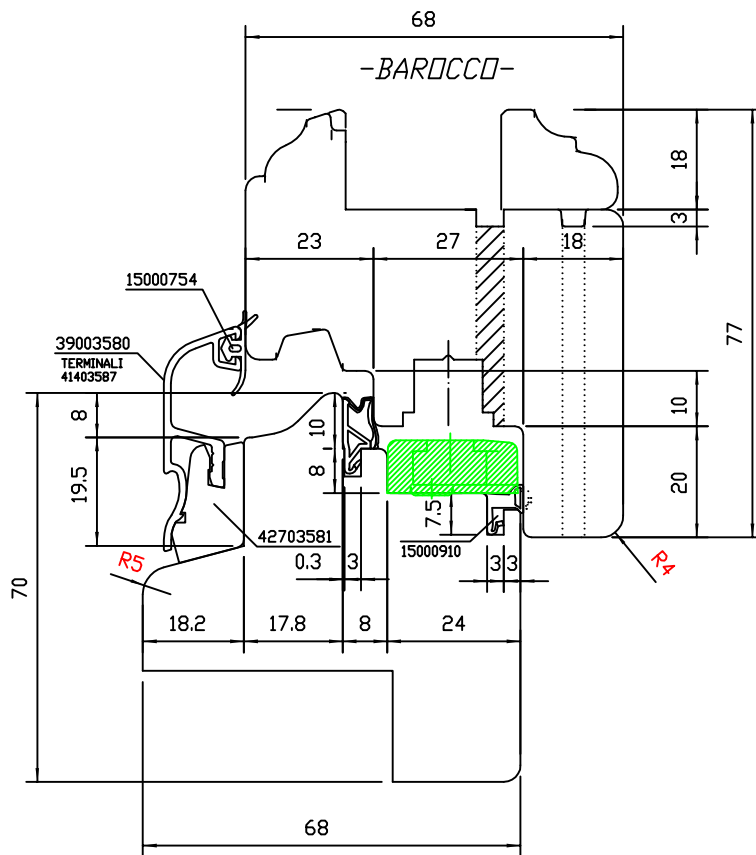

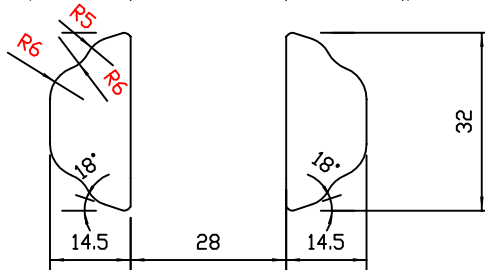

Machinery - Macchina	Weight-Peso Kg	Client reference- RIF.Cliente ALBERTONE SERRAMENTI S.R.L.	Part- Parte
		Description Descrizione ESPERIA 68/68 GT	Drawing n°- Disegno n. 00A/1
		Signature Firma	Code n°- Codice n. 07905 SERIE_TF 0029613
REPLICATION END/OR TRANSMISSION TO OTHERS IS FORBIDDEN RIPRODUZIONE E TRASMISSIONE A TERZI VIETATA		Scale Scala Date Data 06/10/14	Signature Firma

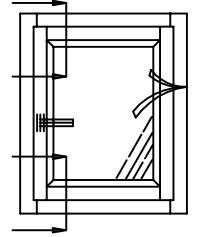
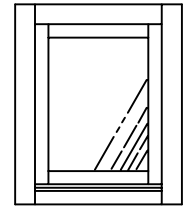
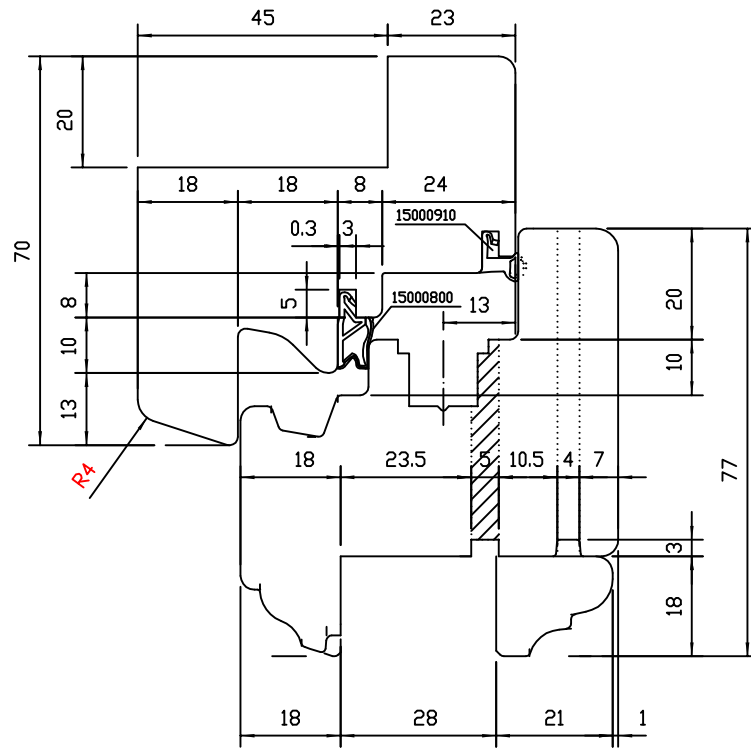

Machinery - Macchina	Weight-Peso Kg	Client reference- RIF.Cliente ALBERTONE SERRAMENTI S.R.L.	Part- Parte
 REKORD HIGH TECHNOLOGY TOOLING ROVERETO (TN) ITALY - Via F.ZENI,8 Tel.0464/443245 REPLICATION END/OR TRASMISSION TO OTHERS IS FORBIDDEN RIPRODUZIONE E TRASMISSIONE A TERZI VIETATA	Description Descrizione ESPERIA 68/68 GT		Drawing n°- Disegno n. 00A/2
	Signature Firma	Scale Scala	Date Data 06/10/14
Revision Rev.	Date Data	Signature Firma	Code n°- Codice n. 07905 SERIE_TF 0029613

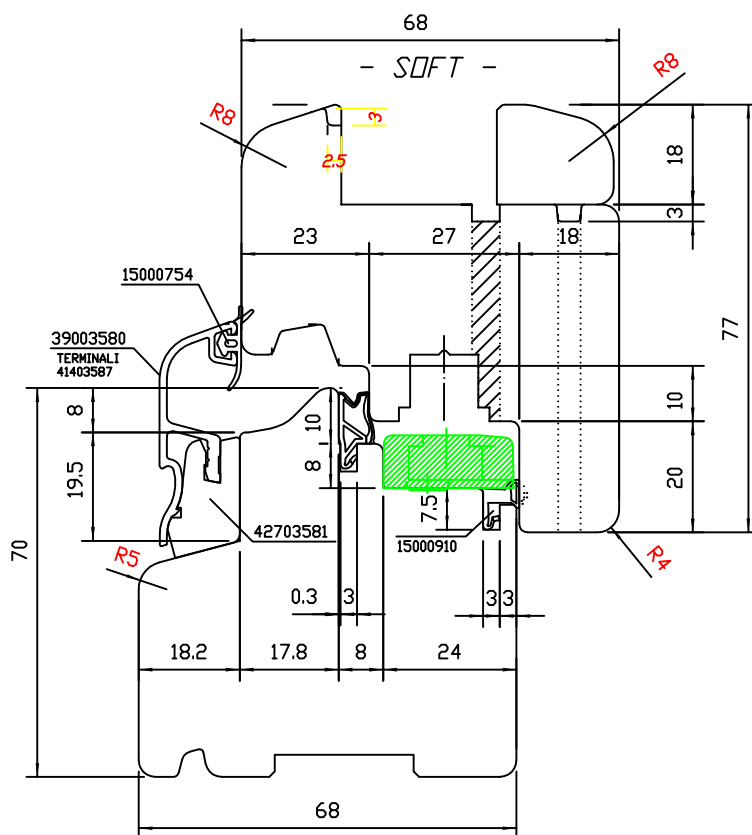
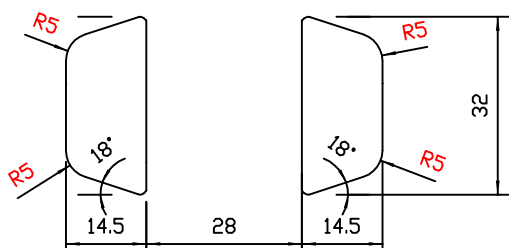
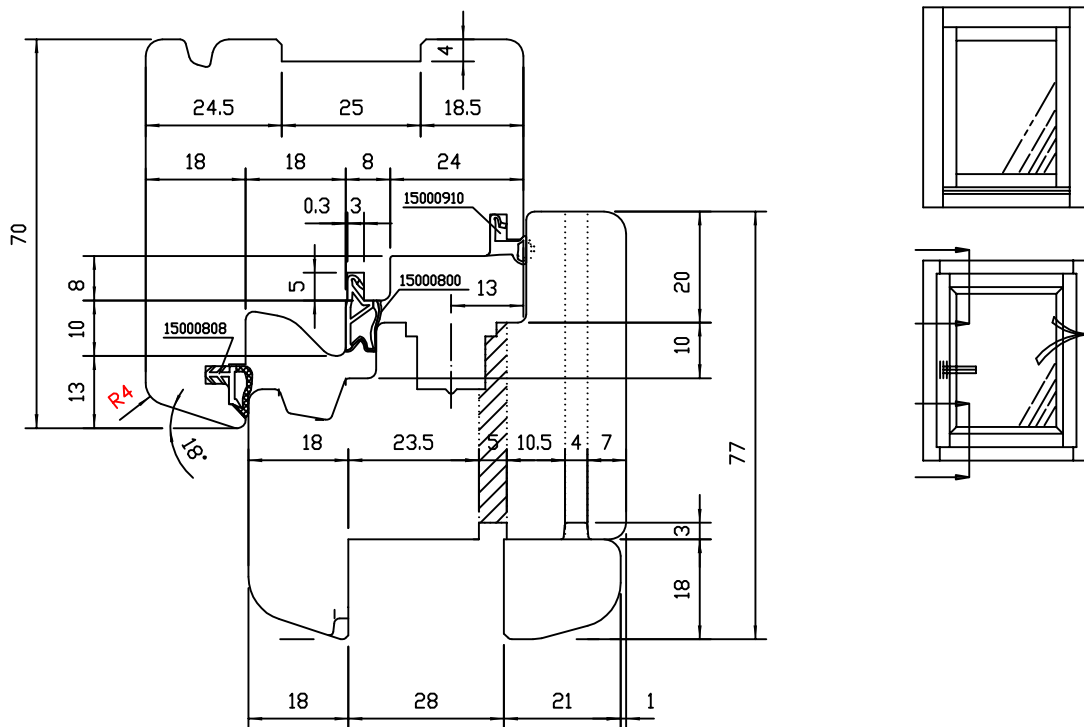

Machinery - Macchina	Weight-Peso Kg	Client reference- RIF.Cliente ALBERTONE SERRAMENTI S.R.L.	Part- Parte
 REKORD HIGH TECHNOLOGY TOOLING ROVERETO (TN) ITALY - Via F.ZENI,8 Tel.0464/443245	Description Descrizione ESPERIA 68/68 GT		Drawing n°- Disegno n. 00A/3
	Signature Firma	Scale Scala	Date Data
Revision Rev.	Date Data	Signature Firma	Code n°- Codice n. 07905 SERIE_TF 0029613

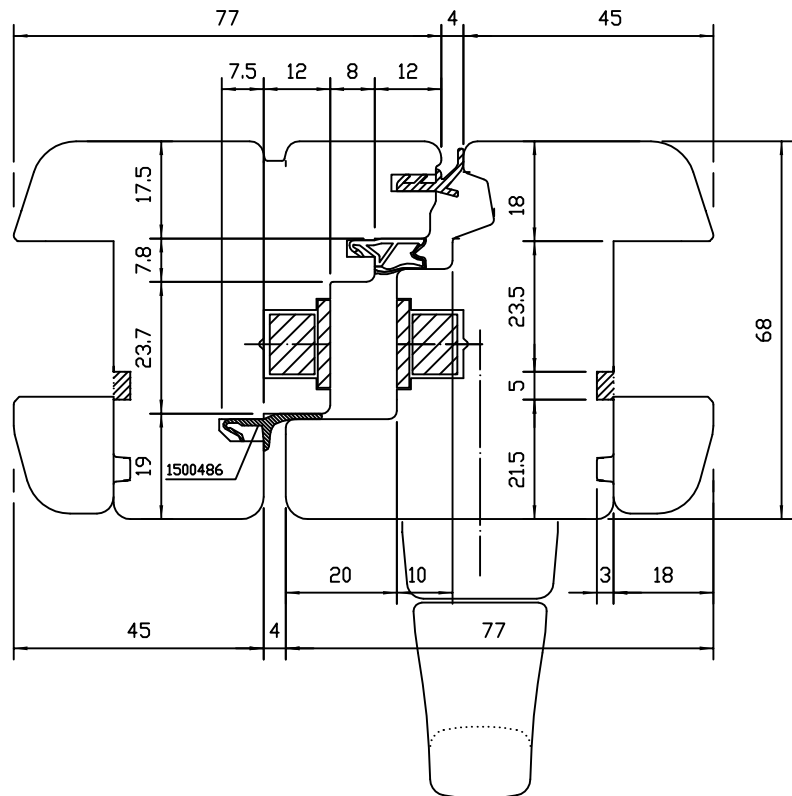
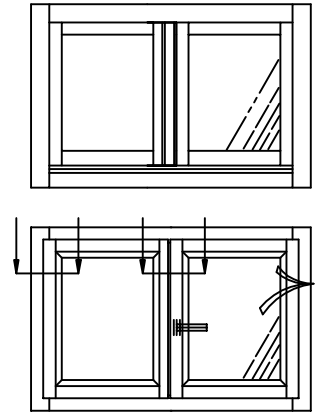
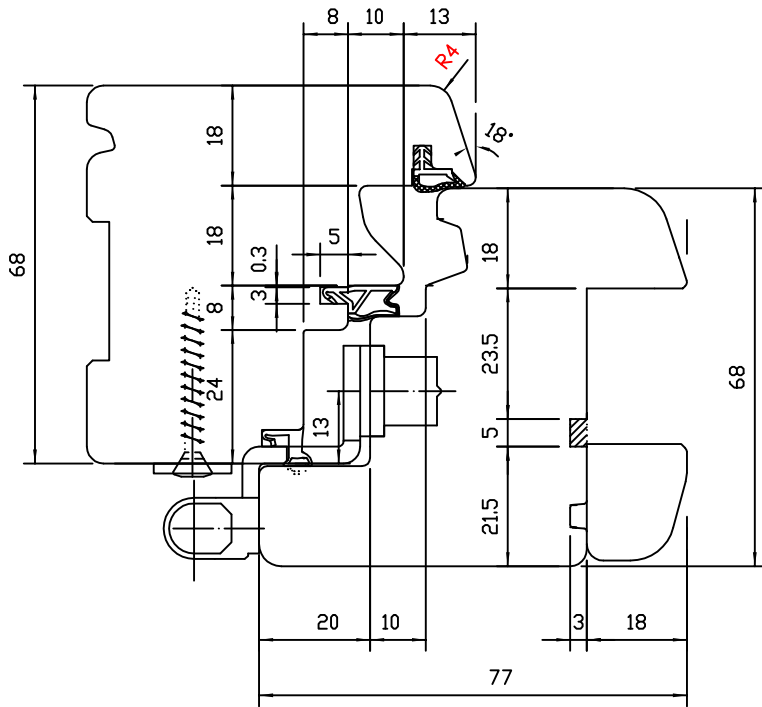

Machinery - Macchina	Weight-Peso Kg	Client reference- RIF.Cliente ALBERTONE SERRAMENTI S.R.L.	Part- Parte
 REKORD HIGH TECHNOLOGY TOOLING ROVERETO (TN) ITALY - Via F.ZENI,8 Tel.0464/443245 <small>REPLICATION END/OR TRASMISSION TO OTHERS IS FORBIDDEN RIPRODUZIONE E TRASMISSIONE A TERZI VIETATA</small>	Description Descrizione ESPERIA 68/68 GT		Drawing n°- Disegno n. 00A/4
	Signature Firma	Scale Scala	Date Data 06/10/14
Revision Rev.	Date Data	Signature Firma	Code n°- Codice n. 07905 SERIE_TF 0029613

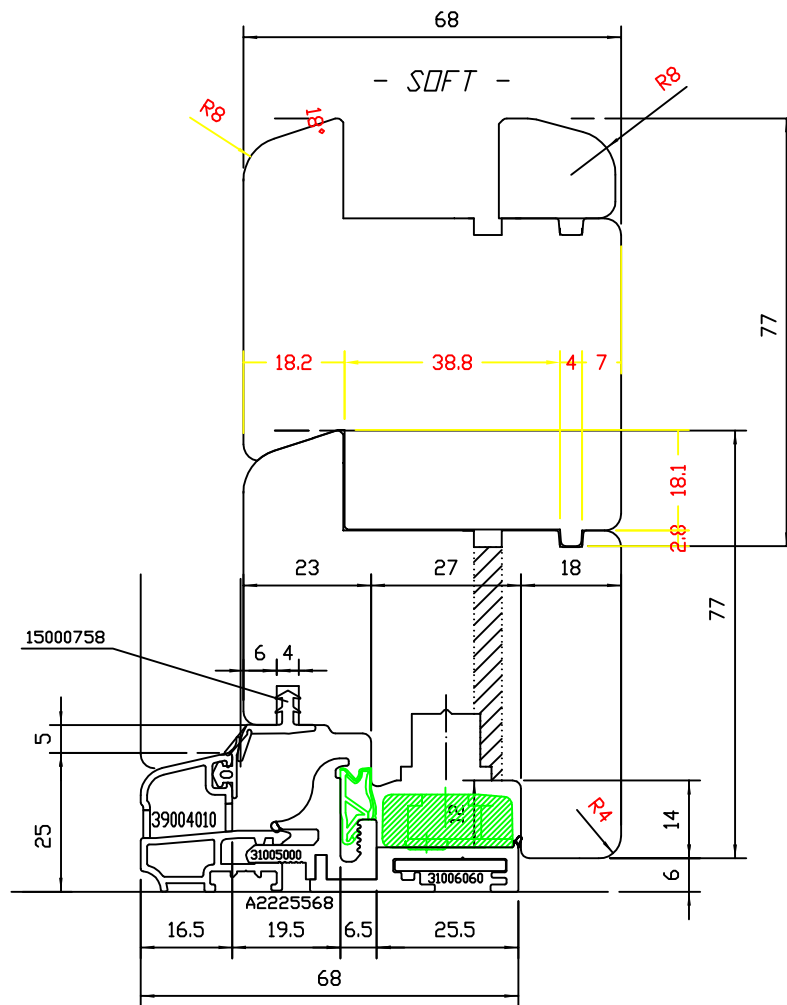
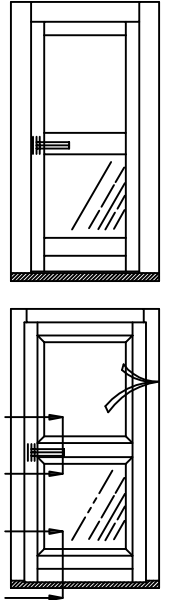
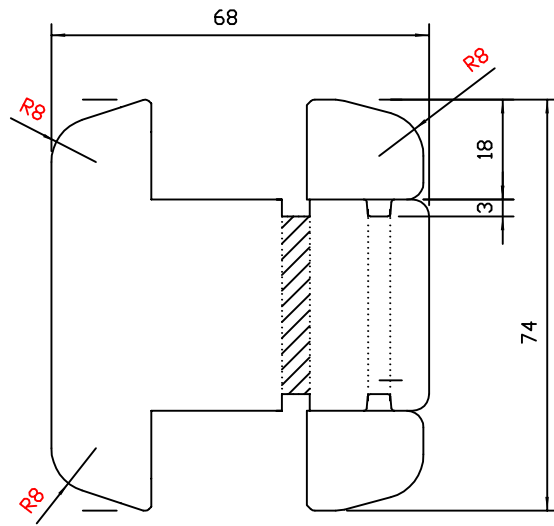

Machinery - Macchina	Weight-Peso Kg	Client reference- Rif.Cliente ALBERTONE SERRAMENTI S.R.L.	Part- Parte
 REKORD HIGH TECHNOLOGY TOOLING ROVERETO (TN) ITALY - Via F.ZENI,8 Tel.0464/443245 <small>REPLICAZIONE ENDO/OR TRASMISSIONE TO OTHERS IS FORBIDDEN RIPRODUZIONE E TRASMISSIONE A TERZI VIETATA</small>	Description Descrizione ESPERIA 68/68 GT		Drawing n°- Disegno n. 00A/5
	Signature Firma	Scale Scala	Date Data 06/10/14
Revision Rev.	Date Data	Signature Firma	